

SYSTEM ADAPTACYJNY TORÓW W PODŁODZE

ADAPTIVE FLOOR TRACK SYSTEM





8-12 mm
16-22 mm
PŁYTA | BOARD



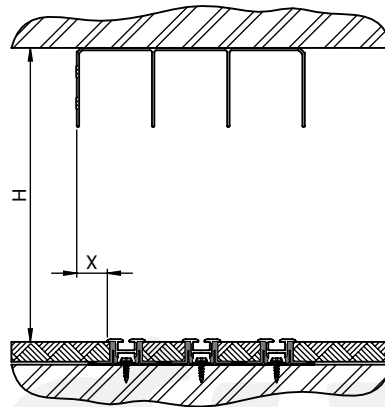
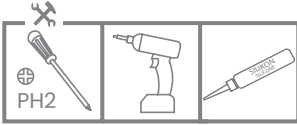

Przed montażem sprawdź zgodność produktu: jakość, ilość i wymiary. W przypadku niezgodności należy niezwłocznie zgłosić ten fakt sprzedawcy.

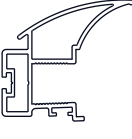
Prior to installation check all elements of the set: finish quality, quantity, dimensions. In case of any issues please contact your supplier.

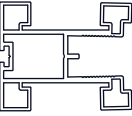
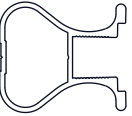

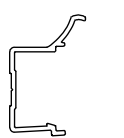
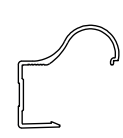
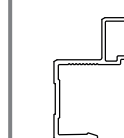
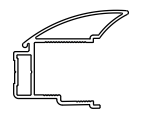
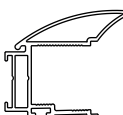
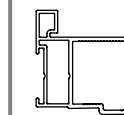
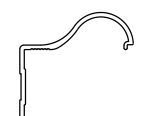
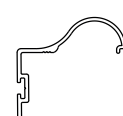
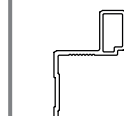
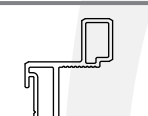
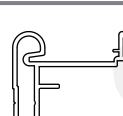
Rodzaj rączki/ Type of handle	Typ systemu/ System type	Odległość X, mm: Distance X, mm:	Wysokość skrzydła H1, mm: Height of door leaf H1, mm:
 TWIN GAMA 88460000	PŁYTA 10 mm/ SZKŁO 4,6 mm na ramiakach NIESYMETRYCZNE BOARD 10 mm/ GLASS 4,6 mm panel holders ASYMMETRICAL	14,7	H1=H-45
 TWIN FLAT 88420000			
 TWIN MULTI 88410000			
 TWIN EPSILON 88480000			
 TWIN 88400000	PŁYTA 10 mm/ SZKŁO 4,6 mm na ramiakach SYMERYCZNE	12,2	H1=H-45
 TWIN LAMBDA 88470000	BOARD 10 mm/ GLASS 4,6 mm panel holders SYMMETRICAL		

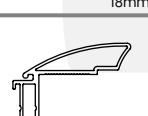
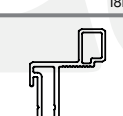
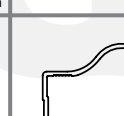
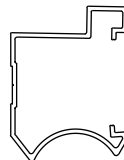
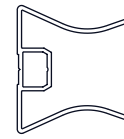
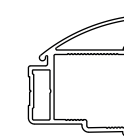
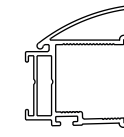
Rodzaj rączki/ Type of handle			Typ systemu/ System type	Odległość X, mm: Distance X, mm:	Wysokość skrzydła H1, mm: Height of door leaf H1, mm:
 HINT 8807000 16mm	 OMEGA R-16 88990000 16mm	 MODERN R-16 88790000 16mm	<p>PŁYTA 16, 18, 19 mm na ceownikach NIESYMETRYCZNE</p> <p>BOARD 16,18,19 mm C-profiles ASYMMETRICAL</p>	17,3	H1=H-45
 MULTIOMEGA 88770000 16mm, 18mm	 MULTIOMEGA WIDE 88710000 16mm, 18mm	 ETA WIDE 88271000 16mm, 18mm			
 OMEGA R18 8886000 18mm	 OMEGA R18 BRUSH 88270000 18mm	 MODERN 88720000 18mm			
 MODERN WIDE 88730000 18mm	 RAMA 88820000 18mm	 RAMA WIDE 88920000 18mm			
 MULTIOMEGA WIDE R-19 88010000 19mm	 MODERN WIDE R-19 88020000 19mm	 OMEGA R-19 88960000 19mm			
 DELTA 88900000					
 INTERO 88130000					
 MULTIOMEGA 88770000			<p>PŁYTA 16, 18, 19 mm/ SZKŁO 4 mm na ramiakach NIESYMETRYCZNE</p> <p>BOARD 16,18,19 mm/ GLASS 4 mm panel holders ASYMMETRICAL</p>	13,3	H1=H-45
 MULTIOMEGA WIDE 88710000					

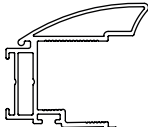
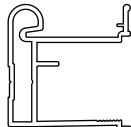
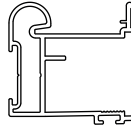
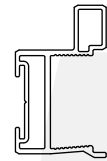
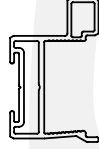
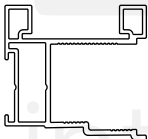
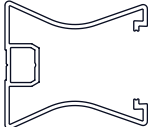
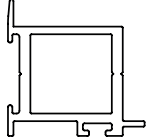
Rodzaj rączki/ Type of handle	Typ systemu/ System type	Odległość X, mm: Distance X, mm:	Wysokość skrzydła H1, mm: Height of door leaf H1, mm:
 <p>MULTIOMEGA WIDE R-19 88010000</p>			
 <p>RAMA 88820000</p>			
 <p>RAMA WIDE 88920000</p>	<p>PŁYTA 16, 18, 19 mm/ SZKŁO 4 mm na ramiakach NIESYMETRYCZNE</p>	13,3	H1=H-45
 <p>MODERN WIDE 88730000</p>	<p>BOARD 16,18,19 mm/ GLASS 4 mm panel holders ASYMMETRICAL</p>		
 <p>MODERN WIDE R-19 88020000</p>			
 <p>ETA WIDE 88271000</p>			
 <p>INTERO 88130000</p>	<p>PŁYTA 18 mm na ramiakach SYMERYCZNE</p> <p>BOARD 18 mm/ panel holders SYMMETRICAL</p>	10,2	H1=H-45
 <p>PROFIL PIONOWY FRAMELESS FRAMELESS VERTICAL PROFILE 88991300</p>	<p>FRAMELESS</p>	14,7	H1=H-47

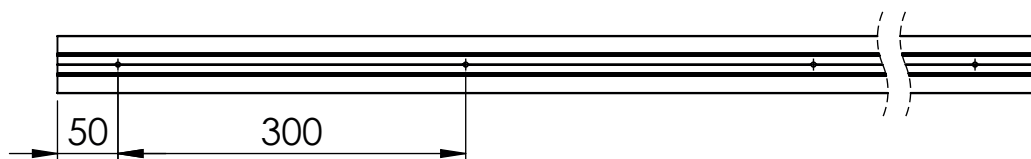
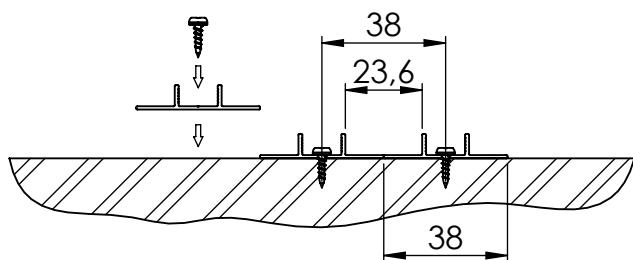
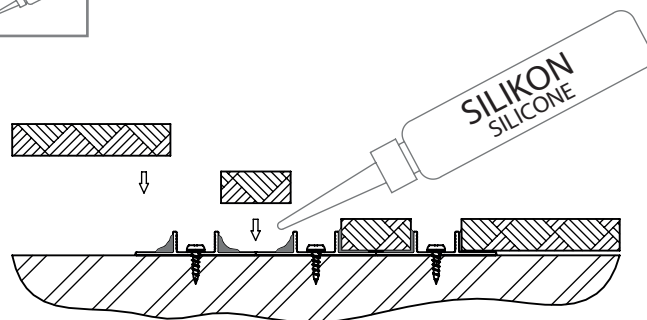
**A****1****A****2****3****C****4**

grubość wypełnienia/
filling thickness
8 - 12 mm

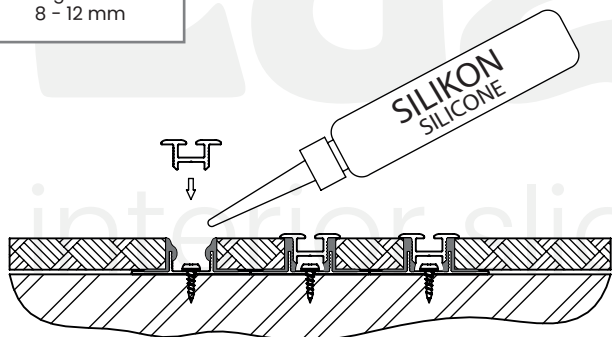
**5**

grubość wypełnienia/
filling thickness
8 - 12 mm

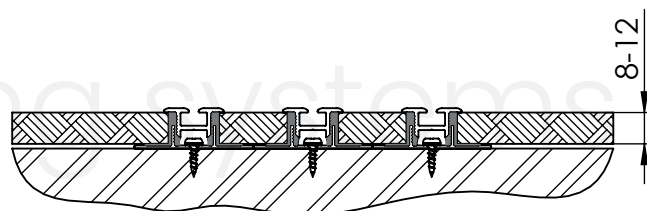

grubość wypełnienia/
filling thickness
16 - 22 mm

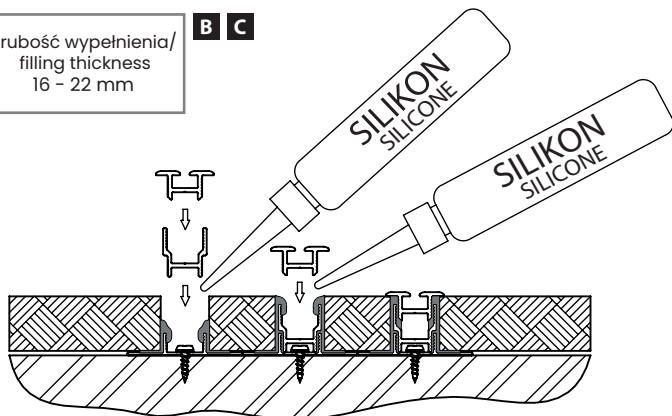
B C

grubość wypełnienia/
filling thickness
16 - 22 mm

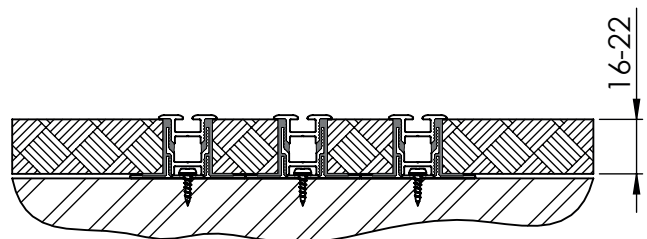

Zaleca się postępowanie zgodnie z niniejszą instrukcją przy użyciu odpowiednich narzędzi, zgodnych ze wskazaniami. W przypadku elementów, których powierzchnia może być ostra należy stosować środki ochrony indywidualnej oraz zabezpieczenie obszaru pracy. Firma Laguna Fabryka Okuć uchyla się od odpowiedzialności za działania wynikające z postępowania niezgodnego z niniejszą instrukcją.

It is recommended that you follow these instructions using the appropriate tools as indicated. In the case of elements whose surface can be sharp, use personal protective equipment and work area protection. The company Laguna Hardware Factory refrains from liability for actions resulting from conduct incompatible with this instruction.